



# MBRB15..CTPbF MBR15..CT-1PbF

SCHOTTKY RECTIFIER

15 Amp

$I_{F(AV)} = 15\text{Amp}$   
 $V_R = 35/45\text{V}$

### Major Ratings and Characteristics



Characteristics	Values	Units
$I_{F(AV)}$ Rectangular waveform	15	A
$V_{RRM}$	35/45	V
$I_{FSM}$ @ tp = 5 $\mu\text{s}$ sine	690	A
$V_F$ @7.5Apk, $T_J=125^\circ\text{C}$	0.57	V
$T_J$	-65 to 150	$^\circ\text{C}$

### Description/ Features

The MBR15.. center tap Schottky rectifier has been optimized for low reverse leakage at high temperature. The proprietary barrier technology allows for reliable operation up to 150° C junction temperature. Typical applications are in switching power supplies, converters, free-wheeling diodes, and reverse battery protection.

- 150° C  $T_J$  operation
- Center tap TO-220 package
- Low forward voltage drop
- High purity, high temperature epoxy encapsulation for enhanced mechanical strength and moisture resistance
- High frequency operation
- Guard ring for enhanced ruggedness and long term reliability
- Lead-Free ("PbF" suffix)

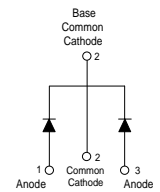
### Case Styles

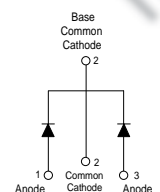
<p><b>MBRB15..CTPbF</b></p>   <p><b>D<sup>2</sup>PAK</b></p>	<p><b>MBR15..CT-1PbF</b></p>   <p><b>TO-262</b></p>
--	---

**Voltage Ratings**

Parameters	MBRB1535CT MBR1535CT-1	MBRB1545CT MBR1545CT-1
V <sub>R</sub> Max. DC Reverse Voltage (V)	35	45
V <sub>RWM</sub> Max. Working Peak Reverse Voltage (V)		

**Absolute Maximum Ratings**

Parameters	Value	Units	Conditions
I <sub>F(AV)</sub> Max. Aver. Forward Current (Per Leg) (Per Device)	7.5 15	A	@ T <sub>C</sub> = 131 °C (Rated V <sub>R</sub> )
I <sub>FSM</sub> Max. Peak One Cycle Non Repetitive Surge	690 150	A	5µs Sine or 3µs Rect. pulse Surge applied at rated load condition halfwave single phase 60Hz Following any rated load condition and with rated V <sub>RRM</sub> applied
E <sub>AS</sub> Non-Repetitive Avalanche Energy	7	mJ	(Per Leg) T <sub>J</sub> = 25 °C, I <sub>AS</sub> = 2 Amps, L = 3.5 mH
I <sub>AR</sub> Repetitive Avalanche Current (Per Leg)	2	A	Current decaying linearly to zero in 1 µsec Frequency limited by T <sub>J</sub> max. V <sub>A</sub> = 1.5 x V <sub>R</sub> typical

**Electrical Specifications**

Parameters	Value	Units	Conditions
V <sub>FM</sub> Max. Forward Voltage Drop (1)	0.84 0.57 0.72	V	@ 15A T <sub>J</sub> = 25 °C @ 7.5A T <sub>J</sub> = 125 °C @ 15A
I <sub>RM</sub> Max. Instantaneous Reverse Current (1)	0.1 15	mA	T <sub>J</sub> = 25 °C T <sub>J</sub> = 125 °C Rated DC voltage
C <sub>T</sub> Max. Junction Capacitance	400	pF	V <sub>R</sub> = 5V <sub>DC</sub> (test signal range 100Khz to 1Mhz) 25°C
L <sub>S</sub> Typical Series Inductance	8.0	nH	Measured from top of terminal to mounting plane
dv/dt Max. Voltage Rate of Change (Rated V <sub>R</sub> )	10000	V/ µs	

(1) Pulse Width < 300µs, Duty Cycle <2%

**Thermal-Mechanical Specifications**

Parameters	Value	Units	Conditions
T <sub>J</sub> Max. Junction Temperature Range	-65 to 150	°C	
T <sub>stg</sub> Max. Storage Temperature Range	-65 to 175	°C	
R <sub>thJC</sub> Max. Thermal Resistance Junction to Case (Per Leg)	3.0	°C/W	DC operation
R <sub>thCS</sub> Typical Thermal Resistance, Case to Heatsink	0.50	°C/W	Mounting surface, smooth and greased
R <sub>thJA</sub> Max. Thermal Resistance Junction	60	°C/W	DC operation
wt Approximate Weight	2 (0.07)	g (oz.)	
T Mounting Torque	Min. 6 (5) Max. 12 (10)	Kg-cm (lbf-in)	
Device Marking	MBRB15..CT MBR15..CT-1		Case style D <sup>2</sup> Pak Case style TO-262

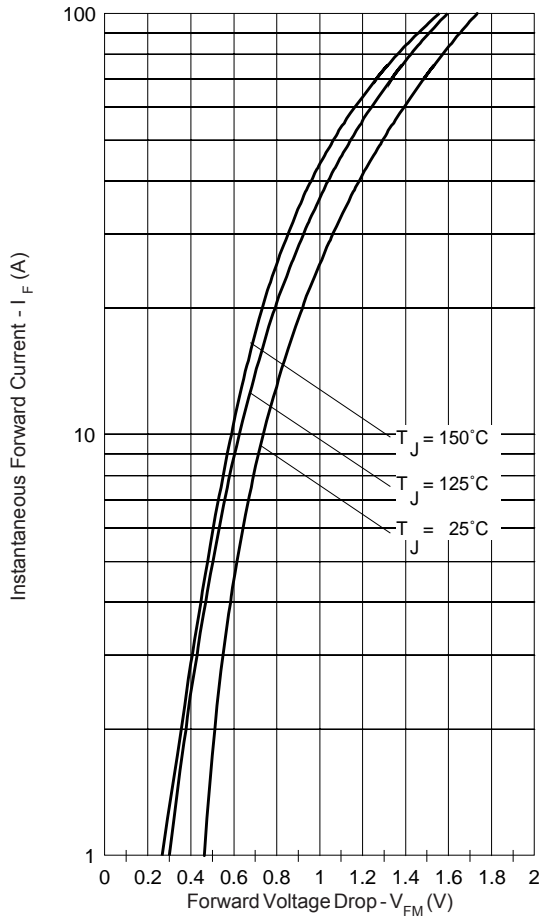

Fig. 1 - Max. Forward Voltage Drop Characteristics (Per Leg)

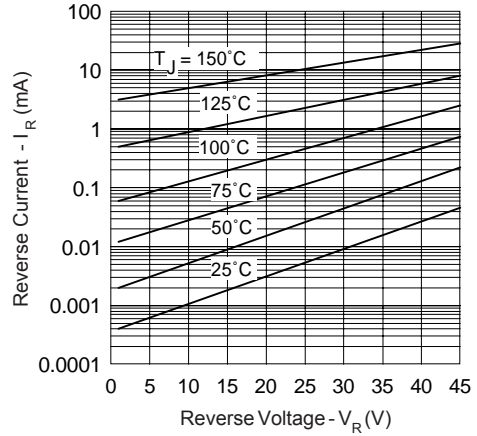

Fig. 2 - Typical Values Of Reverse Current Vs. Reverse Voltage (Per Leg)

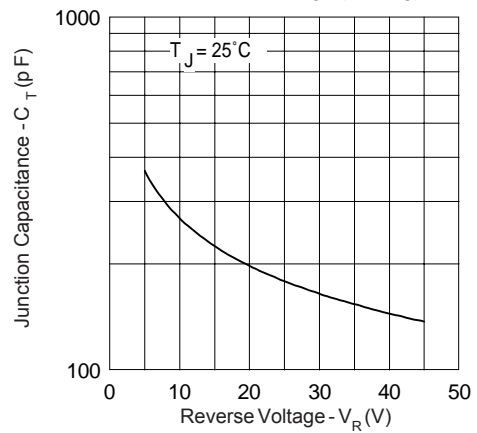

Fig. 3 - Typical Junction Capacitance Vs. Reverse Voltage (Per Leg)

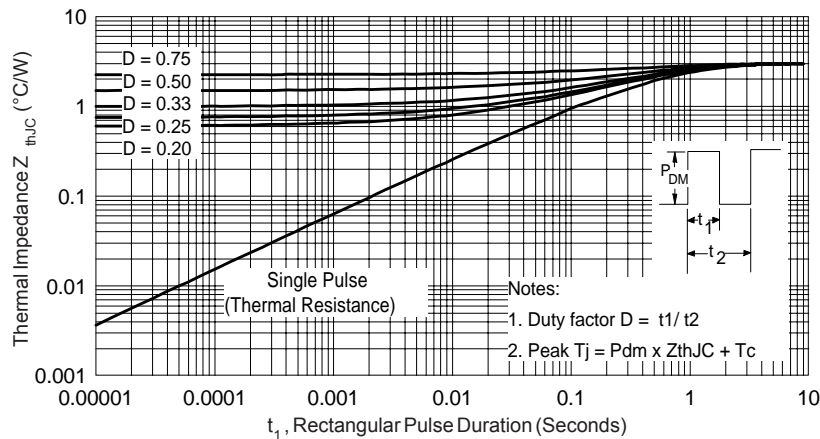

Fig. 4 - Max. Thermal Impedance  $Z_{thJC}$  Characteristics (Per Leg)

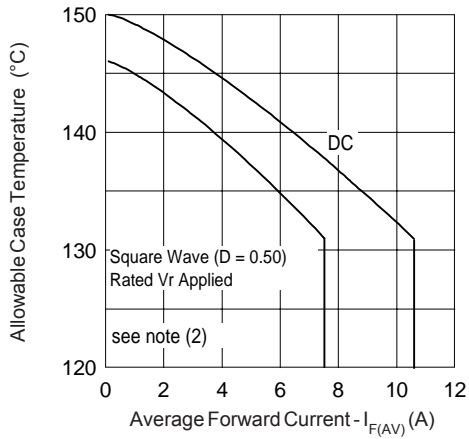

Fig. 5 - Max. Allowable Case Temperature Vs. Average Forward Current

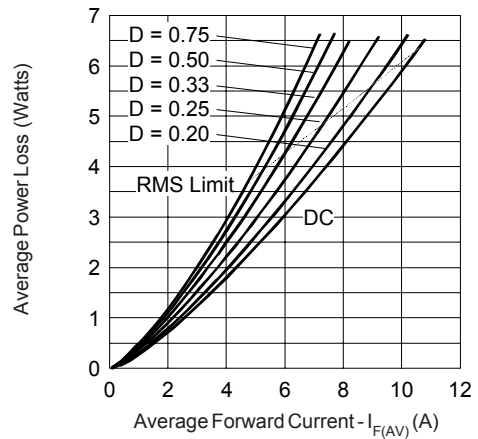

Fig. 6 - Forward Power Loss Characteristics

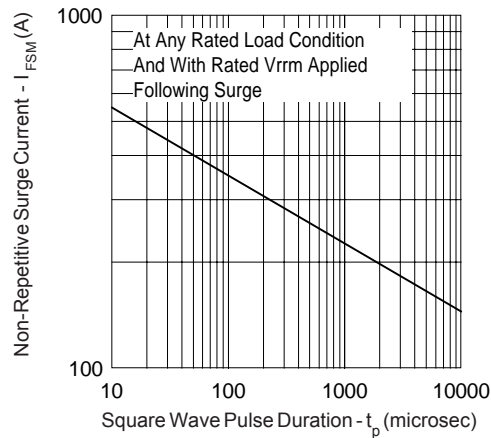
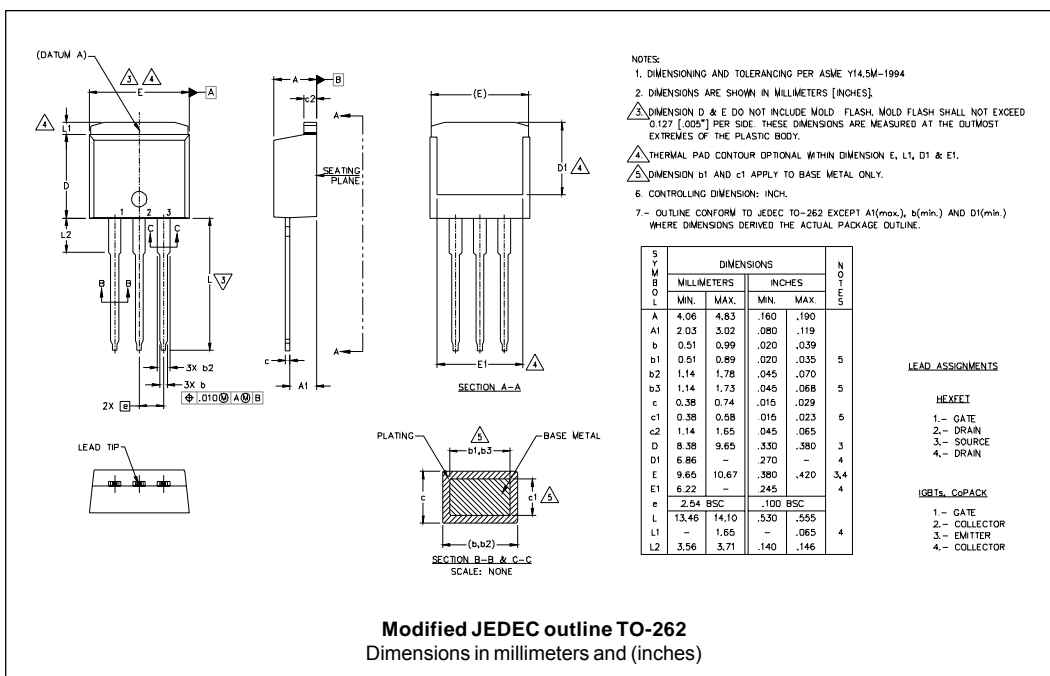
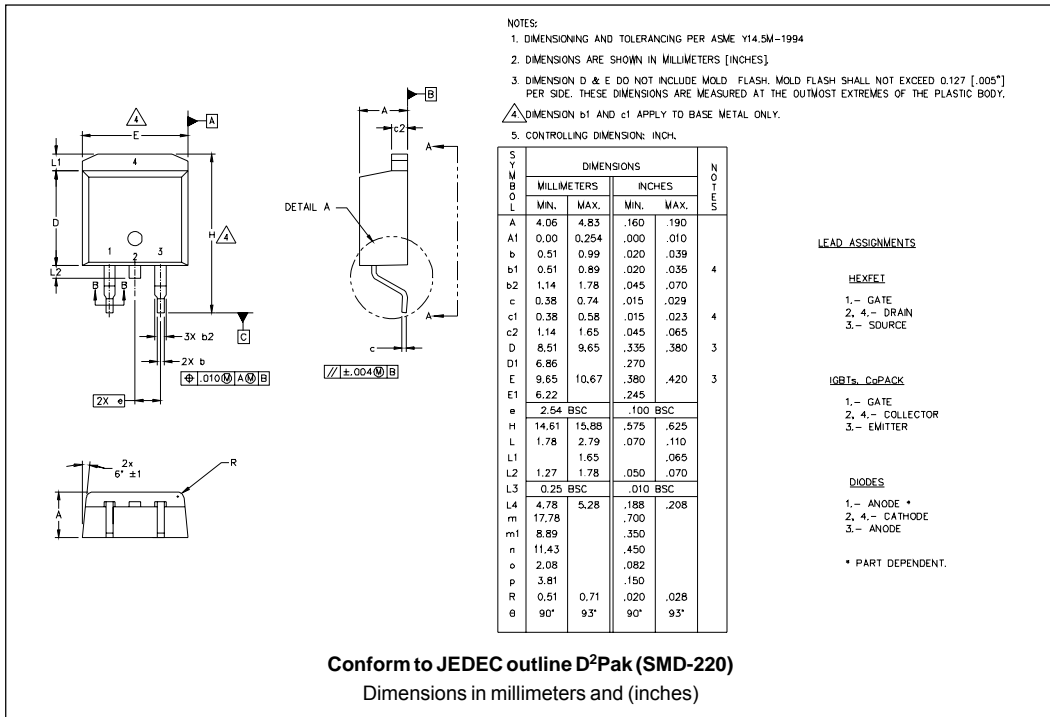

Fig. 7 - Max. Non-Repetitive Surge Current (Per Leg)

(2) Formula used:  $T_C = T_J - (Pd + Pd_{REV}) \times R_{thJC}$ ;  
 $Pd = \text{Forward Power Loss} = I_{F(AV)} \times V_{FM} @ (I_{F(AV)} / D)$  (see Fig. 6);  
 $Pd_{REV} = \text{Inverse Power Loss} = V_{R1} \times I_R (1 - D)$ ;  $I_R @ V_{R1} = \text{rated } V_R$

Outlines Table



Part Marking Information

**D<sup>2</sup>PAK**

EXAMPLE: THIS IS A MBRB1545CT  
LOT CODE 8024  
ASSEMBLED ON WW 02, 2000

Note: "P" in assembly line position indicates "Lead-Free"

INTERNATIONAL RECTIFIER LOGO

ASSEMBLY LOT CODE

PART NUMBER

DATE CODE

YEAR 0 = 2000  
WEEK 02  
P = LEAD-FREE

**TO-262**

EXAMPLE: THIS IS A MBR1545CT-1  
LOT CODE 1789  
ASSEMBLED ON WW 19, 2002

Note: "P" in assembly line position indicates "Lead-Free"

INTERNATIONAL RECTIFIER LOGO

ASSEMBLY LOT CODE

PART NUMBER

DATE CODE

YEAR 2 = 2002  
WEEK 19  
P = LEAD-FREE

Tape & Reel Information

SECTION Y-Y

Ao	10.50	+/- 0.1
B0	15.80	+/- 0.1
B2	10.25	+/- 0.1
K0	4.90	+/- 0.1
F	11.50	+/- 0.1
P1	16.00	+/- 0.1
W	24.00	+/- 0.3

NOTES:

- 1.0 10 SPROCKET HOLE PITH CUMULATIVE TOLERANCE ±.02
- 2.0 CAMBER NOT TO EXCEED 1mm in 100mm
- 3.0 MATERIAL: CONDUCTIVE BLACK STYRENIC ALLOY
- 4.0 K0 MEASURED FROM A PLANE ON THE INSIDE BOTTOM OF THE POCKET TO THE TOP SURFACE OF THE CARRIER
- 5.0 MEASURED FROM CENTRELINE OF SPROCKET HOLE TO CENTRELINE OF POCKET
- 6.0 VENDOR: (OPTIONAL)
- 7.0 MUST ALSO MEET REQUIREMENTS OF EIA STANDAR #EIA-481A TAPING OF SURFACE MOUNT COMPONENTS FOR AUTOMATIC PLACEMENT
- 8.0 SURFACE RESISTIVITY OF MOLDED MATL. MUST MEASURE LESS OR EQUAL TO 10<sup>6</sup> OHMS PER SQUARE. MEASURED IN ACCORDANCE TO PROCEDURE GIVEN IN ASTM D-257 & ASTM D-991
- 9.0 TOTAL LENGTH PER REEL MUST BE 45 METERS
- 10.0 © CRITICAL

Dimensions in millimeters and (inches)

Ordering Information Table

Device Code																	
	<table border="1" style="margin: auto;"> <tr> <td style="padding: 5px;"><b>MBR</b></td> <td style="padding: 5px;"><b>B</b></td> <td style="padding: 5px;"><b>15</b></td> <td style="padding: 5px;"><b>45</b></td> <td style="padding: 5px;"><b>CT</b></td> <td style="padding: 5px;"><b>-1</b></td> <td style="padding: 5px;"><b>TRL</b></td> <td style="padding: 5px;"><b>PbF</b></td> </tr> <tr> <td style="text-align: center;">①</td> <td style="text-align: center;">②</td> <td style="text-align: center;">③</td> <td style="text-align: center;">④</td> <td style="text-align: center;">⑤</td> <td style="text-align: center;">⑥</td> <td style="text-align: center;">⑦</td> <td style="text-align: center;">⑧</td> </tr> </table>	<b>MBR</b>	<b>B</b>	<b>15</b>	<b>45</b>	<b>CT</b>	<b>-1</b>	<b>TRL</b>	<b>PbF</b>	①	②	③	④	⑤	⑥	⑦	⑧
<b>MBR</b>	<b>B</b>	<b>15</b>	<b>45</b>	<b>CT</b>	<b>-1</b>	<b>TRL</b>	<b>PbF</b>										
①	②	③	④	⑤	⑥	⑦	⑧										
<b>1</b>	- Essential Part Number																
<b>2</b>	- B = Surface Mount None = TO-220																
<b>3</b>	- Current Rating (15 = 15A)																
<b>4</b>	- Voltage code: Code = $V_{RRM}$																
<b>5</b>	- CT = Essential Part Number																
<b>6</b>	- "-1" = TO-262																
<b>7</b>	- <ul style="list-style-type: none"> <li>• none = Tube (50 pieces)</li> <li>• TRL = Tape &amp; Reel (Left Oriented - for D<sup>2</sup>Pak only)</li> <li>• TRR = Tape &amp; Reel (Right Oriented - for D<sup>2</sup>Pak only)</li> </ul>																
<b>8</b>	- <ul style="list-style-type: none"> <li>• none = Standard Production</li> <li>• PbF = Lead-Free</li> </ul>																

35	= 35V
40	= 40V
45	= 45V

```

MBR1545CT
*****
*       This model has been developed by       *
*       Wizard SPICE MODEL GENERATOR (1999)   *
*       (International Rectifier Corporation)   *
*       contains Proprietary Information      *
*****
* SPICE Model Diode is composed by a          *
* simple diode plus paralalled VCG2T         *
*****
.SUBCKT MBR1545 ANO CAT
D1 ANO 1 DMOD (0.03191)
*Define diode model
.MODEL DMOD D (IS=9.72464638473799E-05A,N=1.30648926537753,BV=52V,
+ IBV=0.195508065728349A,RS= 0.000727548,CJO=1.94829876431799E-08,
+ VJ=2.27282978121533,XTI=2, EG=0.854458710837653)
*****
*Implementation of VCG2T
VX 1 2 DC 0V
R1 2 CAT TRES 1E-6
.MODEL TRES RES (R=1,TC1=27.6281424524011)
GP1 ANO CAT VALUE={-ABS(I(VX))*(EXP(((((-5.219758E-03/27.62814)*(V(2,CAT)*1E6)/
(I(VX)+1E-6)-1))+1)*7.000165E-02*ABS(V(ANO,CAT)))-1}
*****
.ENDS MBR1545

Thermal Model Subcircuit
.SUBCKT MBR1545 5 1

CTHERM1      5      4      1.05E+00
CTHERM2      4      3      4.44E+00
CTHERM3      3      2      1.16E+01
CTHERM4      2      1      6.12E+01

RTHERM1      5      4      1.33E+00
RTHERM2      4      3      1.19E+00
RTHERM1      3      2      3.81E-01
RTHERM1      2      1      9.54E-02

.ENDS MBR1545
    
```

Data and specifications subject to change without notice.  
 This product has been designed and qualified for Industrial Level and Lead-Free.  
 Qualification Standards can be found on IR's Web site.